

Matera Pergola + 3 RS Smart

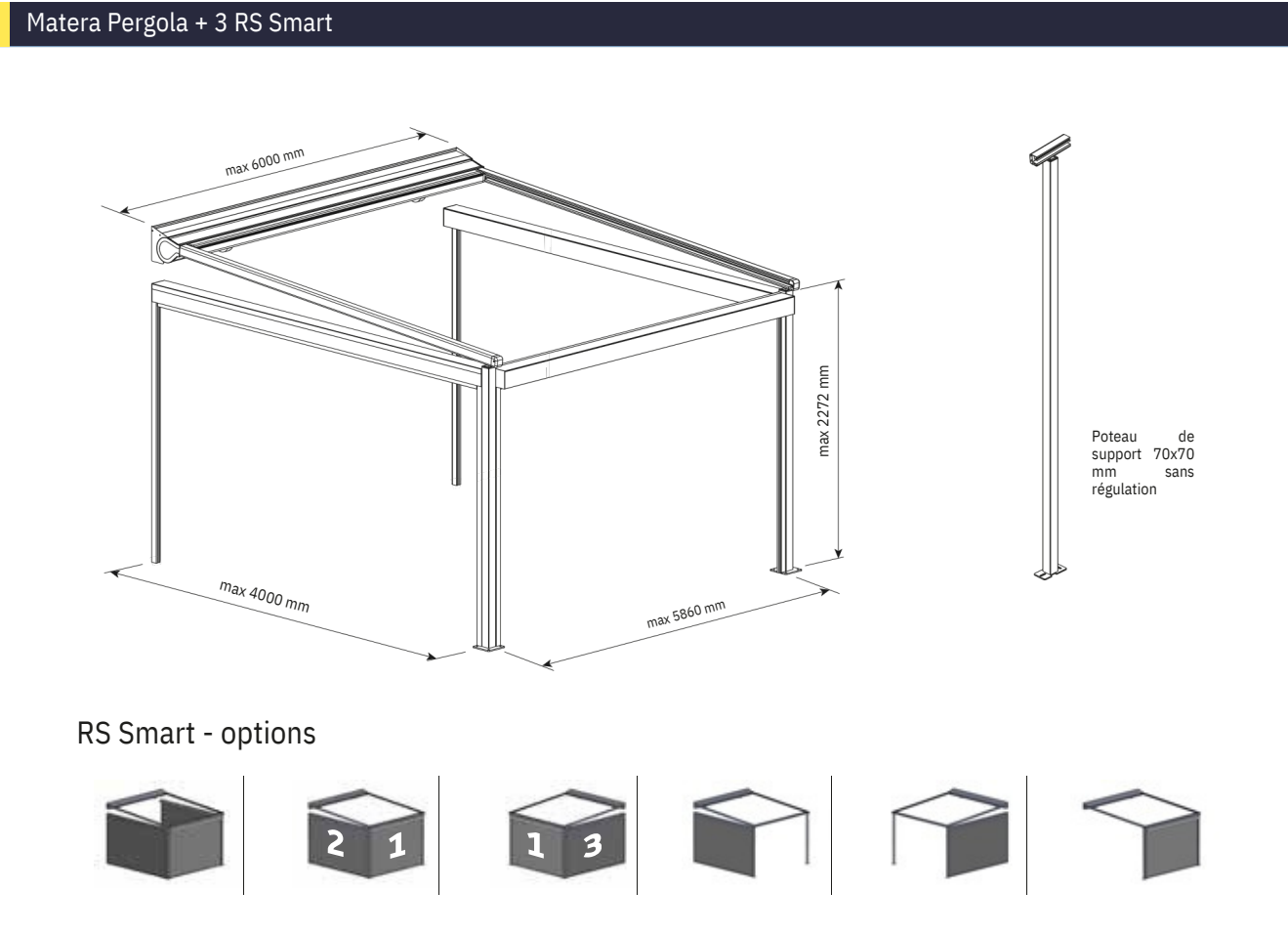

Matera Pergola + RS Smart

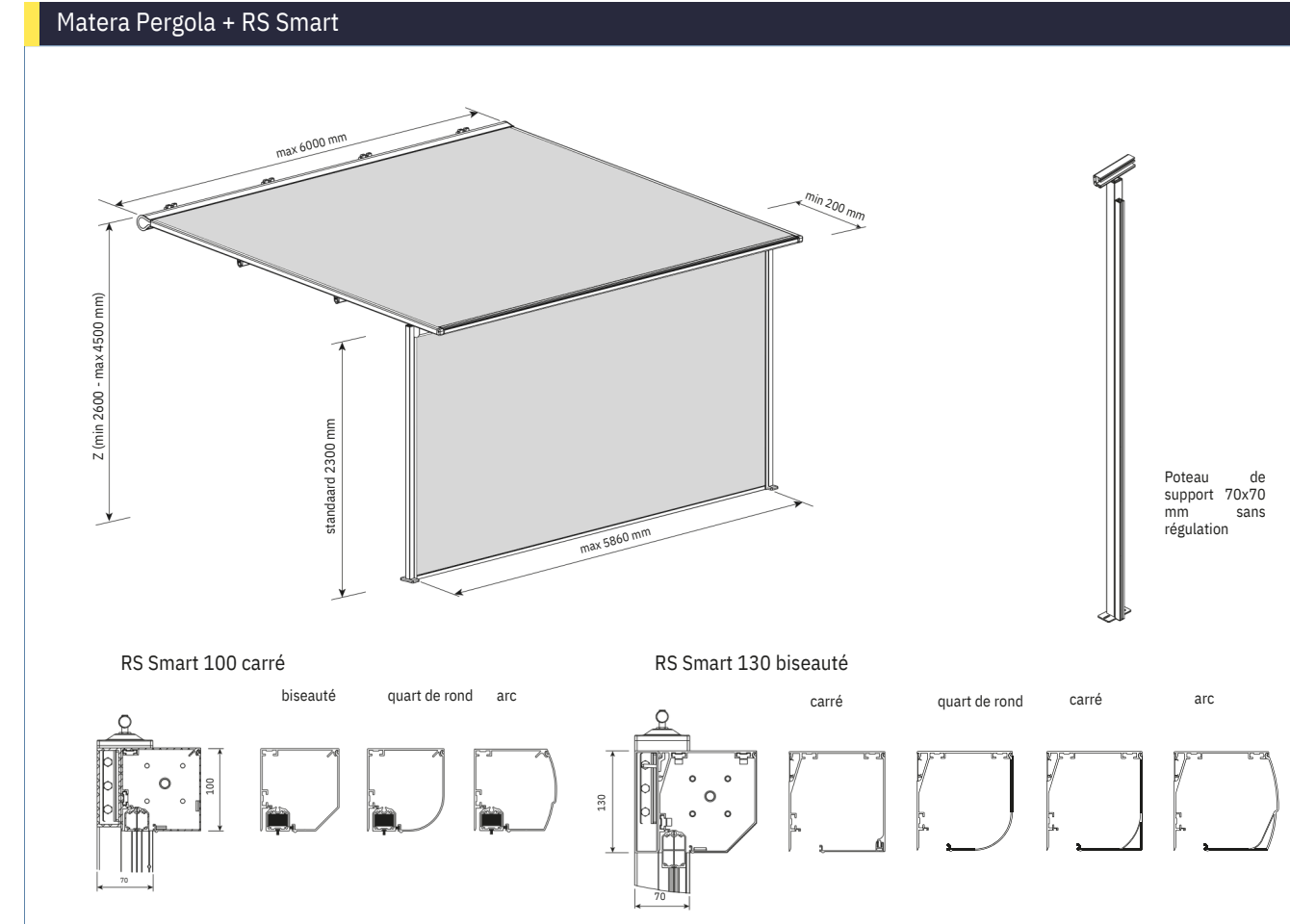

Disponible en 3 couleurs standard: (couleur RAL proche de)



Matera

MATERA, store rétractable sur pieds, un produit combinant un store de terrasse avec une pergola, avec une simplicité de mise en oeuvre .
Les plus grands avantages de ce produit :
Largeur 600 cm avancée 500 cm, toile zippée pour une tension permanente, structure légère mise en oeuvre simplifiée, ajustement de la pente de 5 à 30 degrés et motorisé. Plusieurs options possibles: Pieds réglables ou fixes, laquage selon nuancier ral en plus des standards et éclairage led.

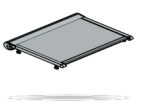

Matera Veranda

Type:
Matera Veranda
pose à plat sur toiture

Dimensions maximales:
600 x 500 cm

Commande:
électrique

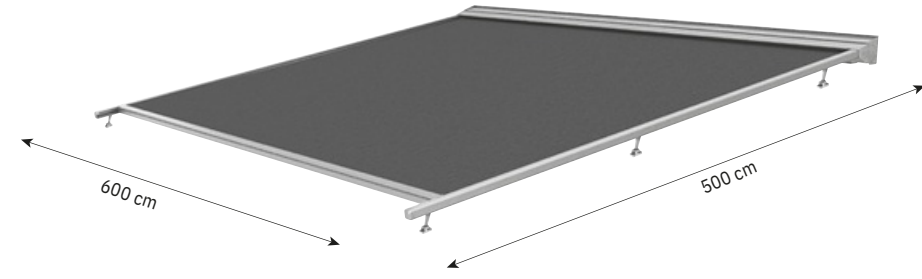

Fixation murale

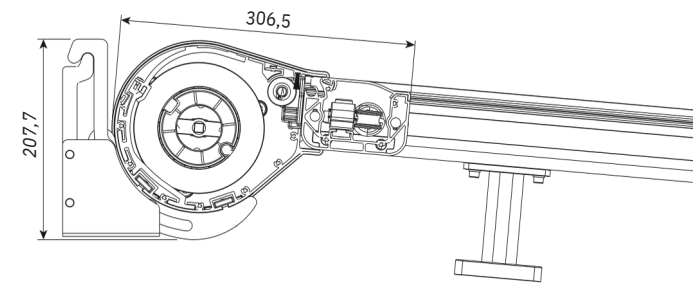

Support mural

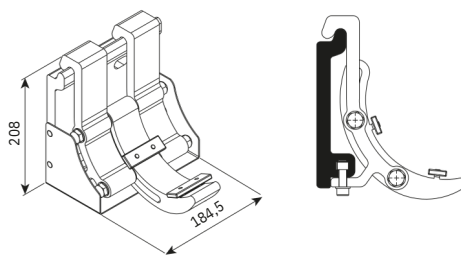

Montage du store posé (les fixations sont optionnelles)

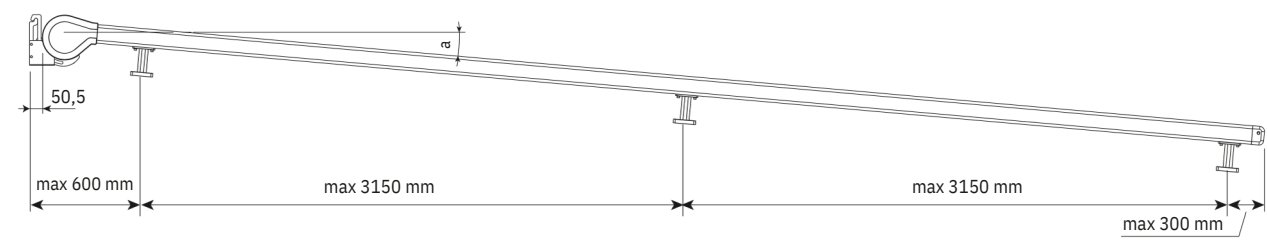

Éléments de montage

barre de charge

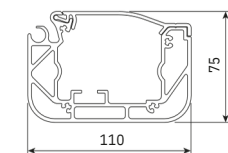

coulisse

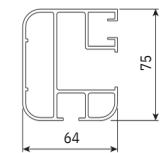

écarteur

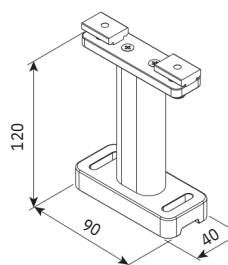

standard

- Hauteur des pieds 73 - 150 mm
- Hauteur totale minimale du pied de montage 120 mm
- Hauteur totale minimale du pied, pied compris, pour une MATERA supérieure à 400 x 400 cm - 120 mm

Matera - avec couplage

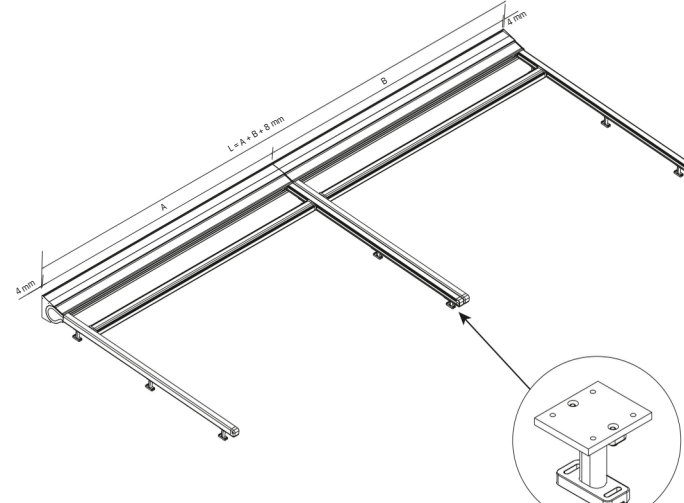

Matera Pergola

Type:
Matera Veranda
pose avec pieds
Dimensions maximales:
600 x 500 cm

Commande:
électrique

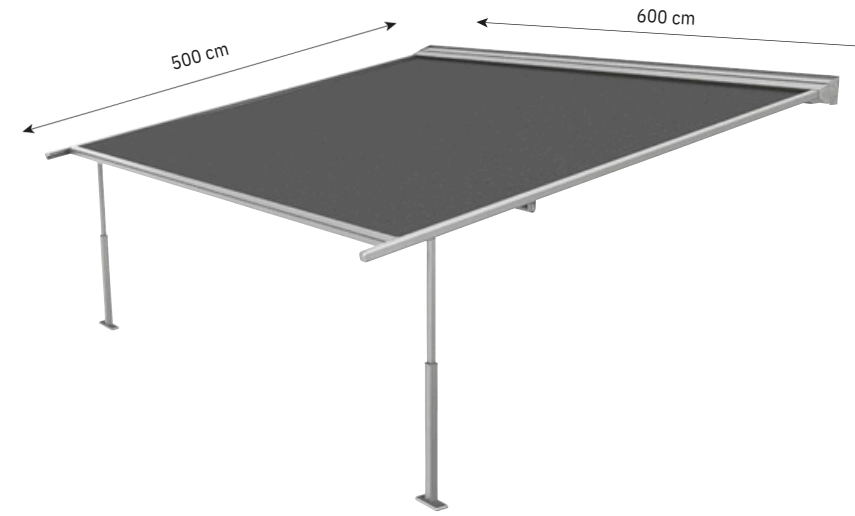

Support mural

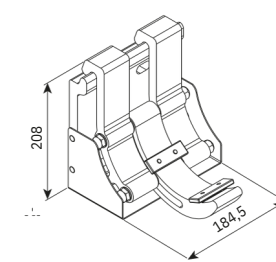
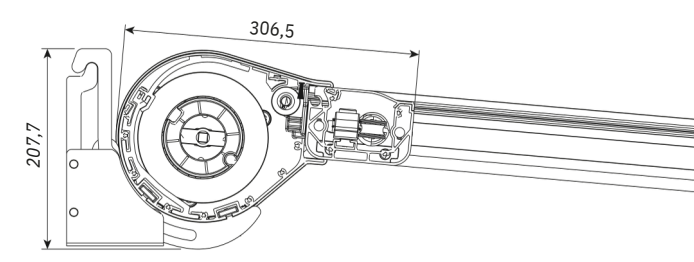

Éléments de montage

barre de charge

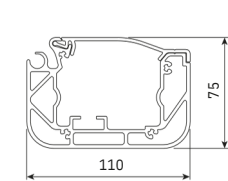

coulisse

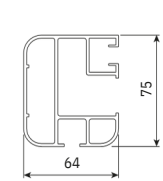

Coiffe Avant - option

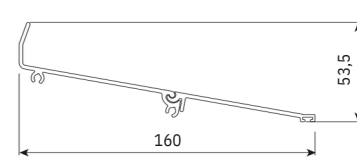

Capot de protection

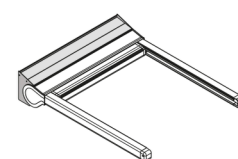

Poteau



standard

Poteau non réglable



Poteau avec régulation de la hauteur

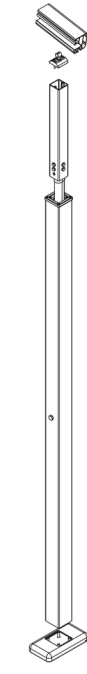

Poteau avec régulation de la hauteur + moteur et télécommande

Éclairage LED

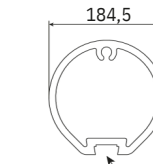
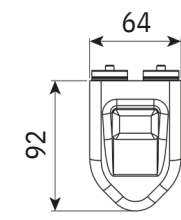
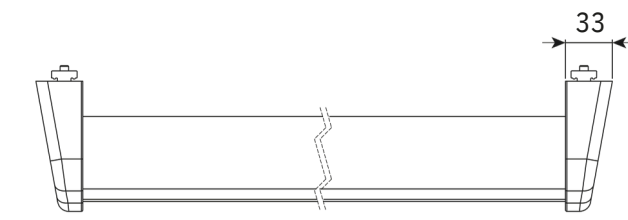

L'espace pour éclairage LED

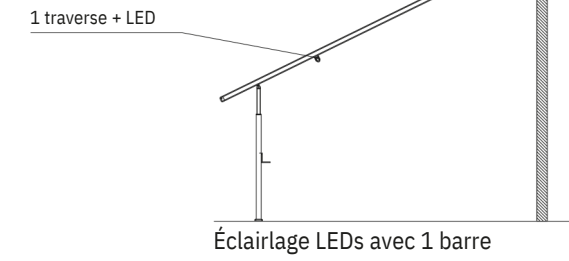

Matera Pergola deux modules

